

Article number: 03507008

Description: Fluro Rod end GE 8FW

## Measures

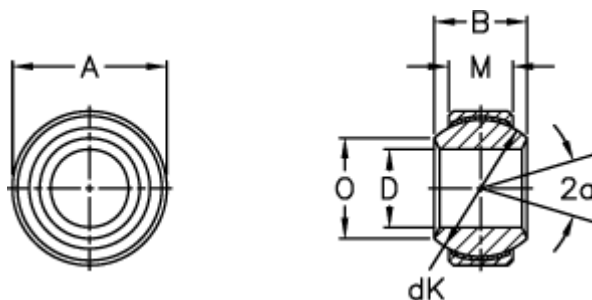

A	= 19 0 -0,009	Tilt angle = 21
B	= 11	Weight = 14
D	= 8 0 -0,008	
dK	= 16	
Dynamic load C (kN)	= 8.6	
M	= 6	
O	= 11.6	
Static load C0 (kN)	= 21.6	